

MORGAN PRODUCTS

PNEUMATIC CHEMICAL PUMPS FOR THE GAS AND OIL INDUSTRIES

MODEL 4755-TR2-SR1S / 4500-TR2-SR1S

AIR ACTUATED POSITIVE DISPLACEMENT PUMP

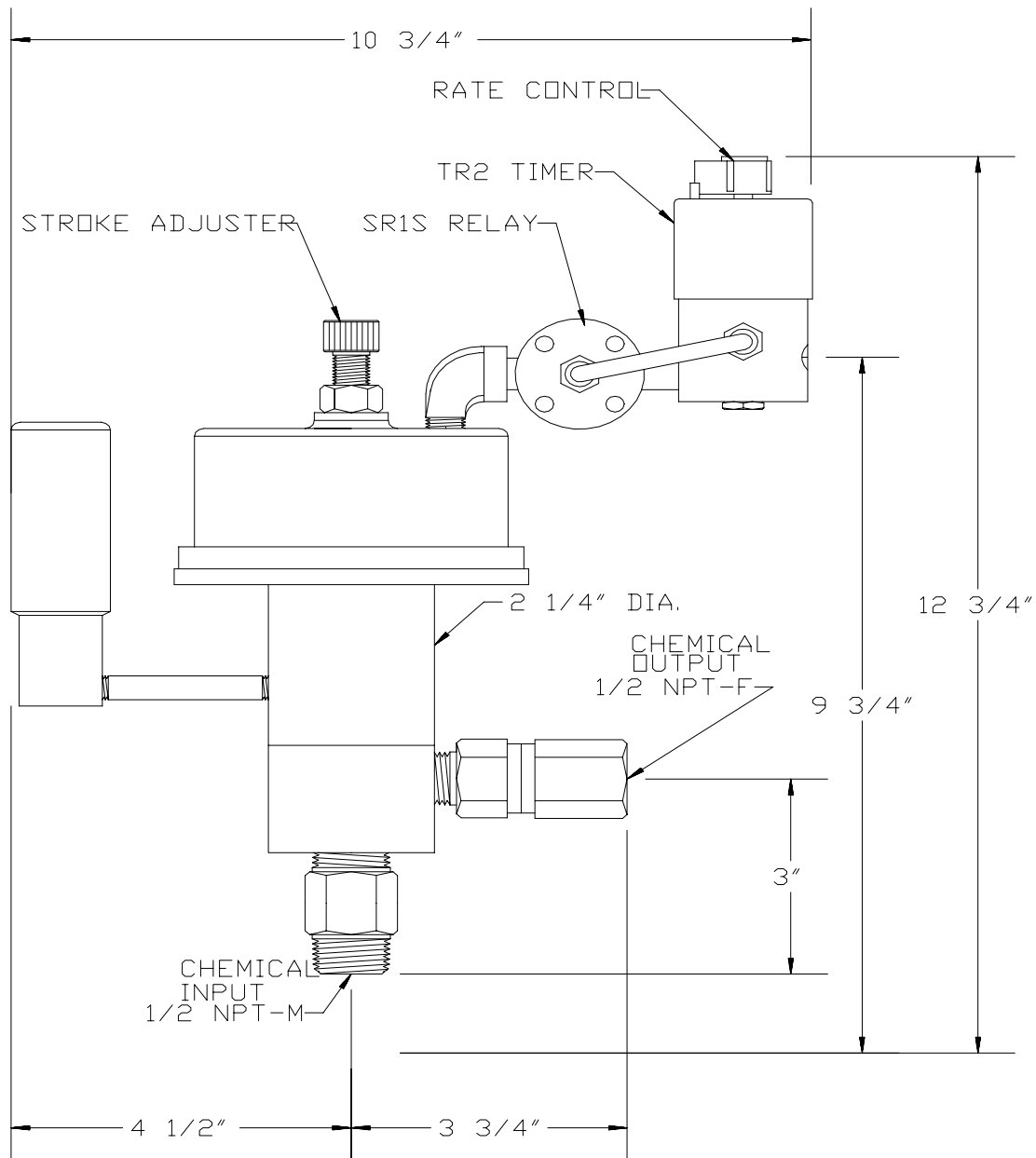

MODEL (WITH TIMER)	DISPLACEMENT	PUMP RATIO	STROKE LENGTH in. - cm.	CONNECTIONS ALL NPT INPUT / OUTPUT	MAXIMUM DISCHARGE PSI - BAR	OUTPUT PER HOUR GAL. / LTS.
4755-TR2-SR1S	7.2cc	24:1	1 - 2.54	3/4 - M / 1/2 - F	3600 - 248	.56 - 5.6 / 2.1 - 21
4500-TR2-SR1S	12.8cc	14:1	1 - 2.54	3/4 - M / 1/2 - F	2100 - 144	1 - 10 / 3.9 - 39

MORGAN PRODUCTS INC. 28103 Ave. Stanford / Valencia, CA 91355

(805) 257-3022 - (800) 421-8910 - FAX (805) 257-3385

www.morganproducts.com - E-Mail info@morganproducts.com

MORGAN PRODUCTS

PNEUMATIC CHEMICAL PUMPS FOR THE GAS AND OIL INDUSTRIES Parts List Model 3500, 4500

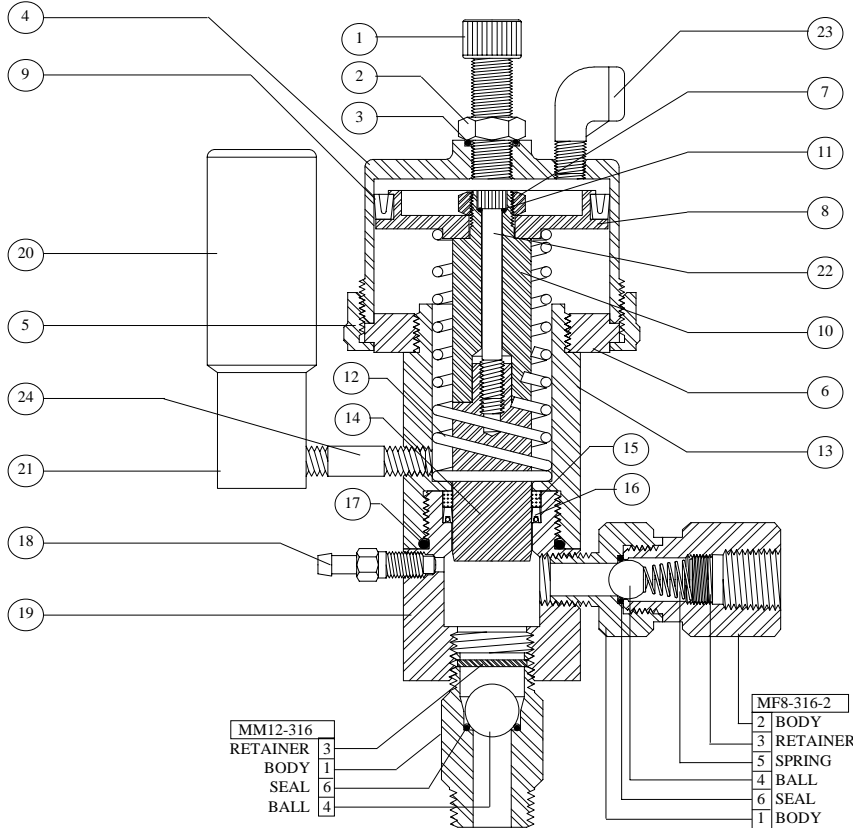

NO	NAME	PART NO.	PUMP MODEL
1	Stroke Adjuster	3000-1	ALL
2	Locknut	3000-2	ALL
3	O-Ring Seal	3000-3 *	ALL
4	Air Chamber	3000-4	3000/3500
		4000-4	4000/4500
5	Air Chamber Ring	3000-5	3000/3500
		4000-5	4000/4500
6	Faceplate	3000-6	3000/3500
		4000-6	4000/4500
7	Piston Locknut	3000-7	ALL
8	Piston	3000-8	3000/3500
		4000-8	4000/4500
9	Piston Seal	300-9 *	3000/3500
		400-9 *	4000/4500
10	Plunger Guide	3000-10	ALL
11	O-Ring Seal	100-3 *	ALL
12	Return Spring	3000-13 *	ALL
13	Oil Chamber	3000-14	ALL
14	Plunger 17-4TN	3000-15 *	ALL
	Plunger 316 SS	3500-17	Optional
15	Back-Up Ring	3000-19 *	ALL
16	Pressure Seal:		
	TG	3000-20*	ALL
	Buna-N	3000-20B	Optional
	Viton	3000-20V	Optional
	Fluoraz	3000-20F	Optional
17	O-Ring Seal	3000-21 *	ALL
18	Bleeder	125-22	ALL
19	Fluid Chamber	3500-23	ALL
20	2 oz. Oil	100-24 *	ALL
21	Reservoir	3000-25	ALL
22	Plunger Bolt	3000-26	ALL
23	Elbow	3000-27	3000/3500
		4000-27	4000/4500
24	Nipple	3000-32	3000/3500
		4000-32	4000/4500
N/S	1oz. Grease	*	ALL
N/S	1/4-20 Cap Screw	4000-28	4000/4500
N/S	1/4 Washer	4000-29	4000/4500
	Repair Kits:		
	W/ 17-4TN Plunger	3000-50	3000/3500
		4000-50	4000/4500
	W/ 316 SS Plunger	3500-50	3000/3500
		4500-50	4000/4500
	Seal Sets:		
	TG	3000-48	ALL
	Buna-N	3000-48B	ALL
	Viton	3000-48V	ALL
	Fluoraz	3000-48F	ALL

* = Included in Repair Kit

INSTALLATION INSTRUCTIONS

1. Discard all red plastic closures.
2. Connect suction check valve, to a gravity fed chemical source.
3. Connect discharge check valve, to process line.
4. Connect a regulated air or gas supply, to the timing relay.
5. Fill oil reservoir with oil provided.
** This must be done BEFORE start up.**
6. Open bleeder valve until chemical flows from bleeder.
7. Set regulator at 10 to 15 psi ABOVE the pressure required.
(See discharge pressure graph).
8. Set cycle rate in strokes per minute.
(See volume graph)

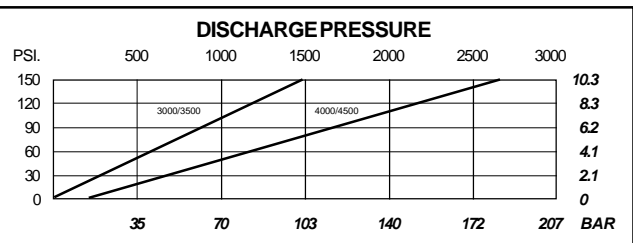
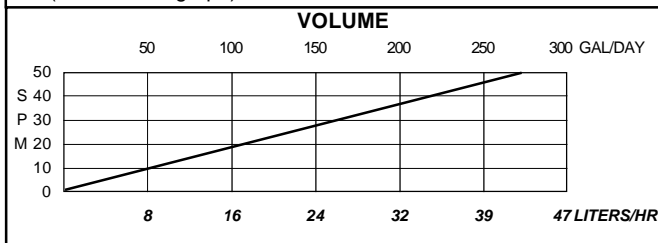

MORGAN PRODUCTS INC. 28103 Ave. Stanford / Valencia, CA 91355

(805) 257-3022 - (800) 421-8910 - FAX (805) 257-3385

MORGAN PRODUCTS

PNEUMATIC CHEMICAL PUMPS FOR THE GAS AND OIL INDUSTRIES

Parts List Model 3755 & 4755

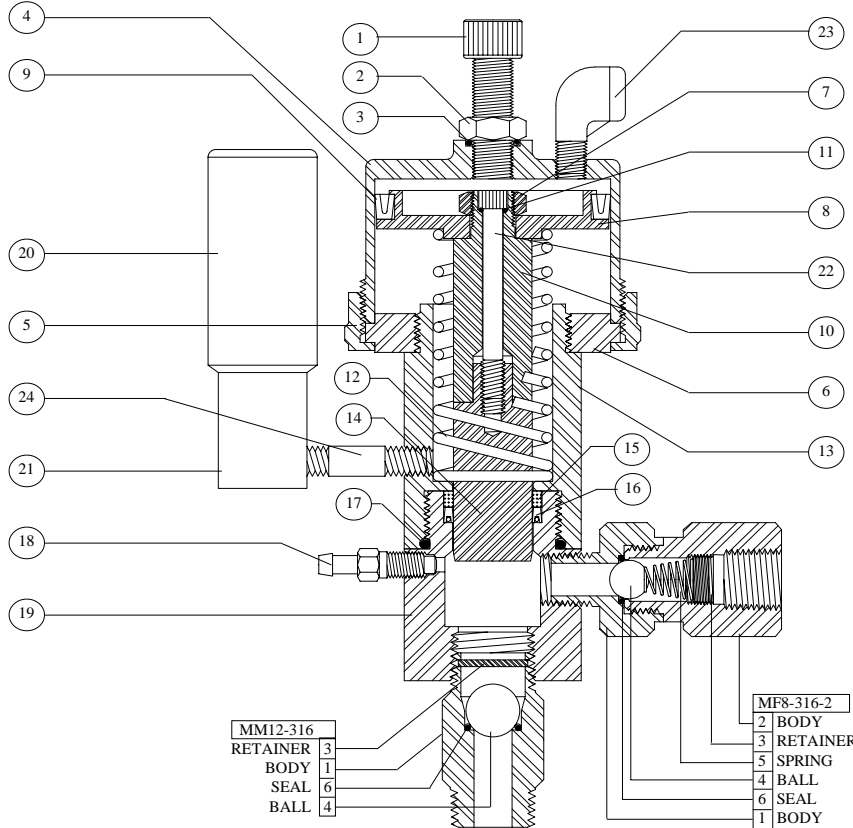

NO	NAME	PART NO.	PUMP MODEL
1	Stroke Adjuster	3000-1	ALL
2	Locknut	3000-2	ALL
3	O-Ring Seal	3000-3 *	ALL
4	Air chamber	3000-4	3755
		4000-4	4755
5	Air Chamber Ring	3000-5	3755
		4000-5	4755
6	Faceplate	3000-6	3755
		4000-6	4755
7	Piston Locknut	3000-7	ALL
8	Piston	3750-8	3755
		4750-8	4755
9	Piston Seal	300-9 *	3755
		400-9 *	4755
10	Plunger Guide	3750-10	ALL
11	O-Ring Seal	100-11 *	ALL
12	Return Spring	3750-13 *	ALL
13	Oil Chamber	3750-14	ALL
14	Plunger 17-4TN	3750-15 *	ALL
	Plunger 316 SS	3755-17	Optional
15	Back-up Ring	3750-19 *+	ALL
16	Pressure Seal:		
	TG	3750-20 *+	ALL
	Buna-N	3750-20B +	Optional
	Viton	3750-20V +	Optional
	Fluoraz	3750-20F +	Optional
17	Body O-Ring Seal	3000-21 *	ALL
18	Bleeder	125-22	ALL
19	Fluid Chamber	3755-23	ALL
20	2 oz. Oil	100-24 *	ALL
21	Reservoir	3000-25	ALL
22	Plunger Bolt	3000-26	ALL
23	Elbow	3000-27	3755
		4000-27	4755
24	Nipple	3000-32	3755
		4000-32	4755
N/S	1oz. Grease		* ALL
N/S	1/4-20 Cap Screw	4000-28 (2)	4755
N/S	1/4 Washer	4000-29 (2)	4755
	Repair Kits:		
	W/ 17-4TN Plunger	3750-50	3755
		4750-50	4755
	W/ 316 SS Plunger	3755-50	3755
		4755-50	4755
	Seal Sets:		
	TG	3750-48	ALL
	Buna-N	3750-48B	ALL
	Viton	3750-48V	ALL
	Fluoraz	3750-48F	ALL

* = Included in Repair Kit
 + = Included in Seal Set

INSTALLATION INSTRUCTIONS

1. Discard all red plastic closures.
2. Connect suction check valve, to a gravity fed chemical source.
3. Connect discharge check valve, to process line.
4. Connect a regulated air or gas supply, to the timing relay.
5. Fill oil reservoir with oil provided.
 ** This must be done BEFORE start up.**
6. Open bleeder valve until chemical flows from bleeder.
7. Set regulator at 10 to 15 psi ABOVE the pressure required.
 (See discharge pressure graph).
8. Set cycle rate in strokes per minute.
 (See volume graph)

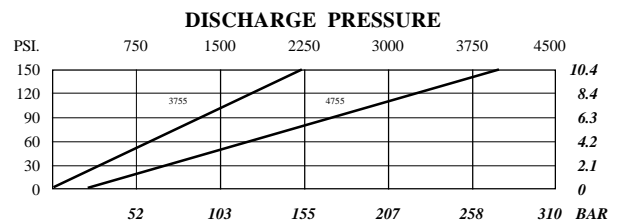
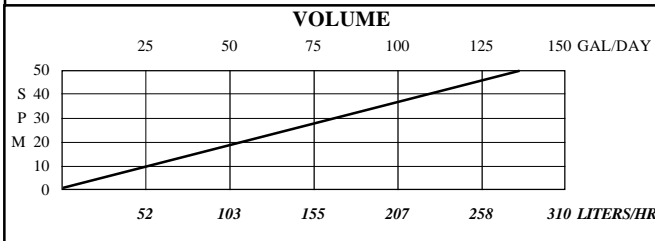

MORGAN PRODUCTS INC. 28103 Ave. Stanford / Valencia, CA 91355

(805) 257-3022 - (800) 421-8910 - FAX (805) 257-3385